

Instruction Manual
DO 6
Economy Hand-held Dissolved Oxygen Meter



OAKTON®

**EUTECH
INSTRUMENTS**

Technology Made Easy...

ISO 9001
CERTIFIED

68X243622
Rev 2 Apr 08

Part of Thermo Fisher Scientific

Preface

This manual serves to explain the use of the DO 6 Dissolved Oxygen Handheld.

This manual functions in two ways: first as a step by step guide to help you operate the meter; second, as a handy reference guide.

This manual is written to cover as many anticipated applications of the DO6 palm-top meter as possible. If there are doubts in the use of the Dissolved Oxygen Handheld, please do not hesitate to contact the nearest Eutech Instruments / Oakton Instruments authorized Distributor.

Eutech Instruments/Oakton Instruments will not accept any responsibility for damage or malfunction to the meter caused by improper use of the instrument.

The information presented in this manual is subject to change without notice as improvements are made, and does not represent a commitment on the part of Eutech Instruments / Oakton Instruments.

Copyright © 2004

Eutech Instruments Pte Ltd

Oakton Instruments

All rights reserved.

TABLE OF CONTENTS

1	INTRODUCTION	1
2	DISPLAY & KEYPAD FUNCTIONS	2
2.1	DISPLAY	2
2.2	KEYPAD	3
3	PREPARATION.....	4
3.1	INSERTING & REMOVING RUBBER BOOT	4
3.2	INSERTING THE BATTERIES	5
3.3	BATTERY REPLACEMENT	6
3.4	DISSOLVED OXYGEN PROBE INFORMATION	7
3.5	CONNECTING THE PROBE TO METER	9
3.6	SWITCHING THE METER ON	10
3.7	MEASUREMENT MODE SELECTION:- PERCENTAGE SATURATION (%), CONCENTRATION (MG/L)(PPM) AND TEMPERATURE(T).....	11
4	CALIBRATION	12
4.1	IMPORTANT INFORMATION ON METER CALIBRATION	12
4.2	PREPARING THE METER FOR CALIBRATION	13
4.3	TEMPERATURE CALIBRATION	15
4.4	DISSOLVED OXYGEN CALIBRATION IN % SATURATION	17
4.4.1	<i>To calibrate 100% Saturation:.....</i>	<i>17</i>
4.4.2	<i>To calibrate 0% Saturation.....</i>	<i>19</i>
4.5	DISSOLVED OXYGEN CALIBRATION IN MG/L OR PPM CONCENTRATION MODE	20
4.5.1	<i>To calibrate in mg/L (ppm) Concentration mode:.....</i>	<i>20</i>
5	MEASUREMENT.....	22
5.1	WITH AUTOMATIC TEMPERATURE COMPENSATION (ATC)	22
5.2	MANUAL TEMPERATURE COMPENSATION	23
5.3	TAKING MEASUREMENTS	25
5.3.1	<i>To take measurements:</i>	<i>25</i>

5.4	TAKING PRESSURE/SALINITY COMPENSATED DO MEASUREMENTS.....	26
5.4.1	<i>Pressure Setting Adjustment</i>	26
5.4.2	<i>Salinity Setting Adjustment</i>	29
6	HOLD FUNCTION.....	30
7	ADVANCED SETUP FUNCTIONS.....	31
7.1	ADVANCED SETUP OVERVIEW.....	31
7.1.1	<i>To enter the % Saturation or Temperature Set Up menu:</i>	31
7.1.2	<i>To enter the mg/L (ppm) Concentration Set Up menu:</i>	31
7.2	(COF.1) CONFIGURATION MENU.....	36
7.2.1	<i>Selection of Automatic Temperature Compensation</i>	36
7.2.2	<i>Selection of mg/L or ppm mode</i>	38
7.3	(CAL.2) CALIBRATION DATA.....	39
7.3.1	<i>Viewing the % Saturation calibration data</i>	39
7.3.2	<i>Viewing the mg/L (ppm) Concentration calibration data</i>	39
7.4	(ELE.3) ELECTRODE PROPERTIES.....	40
7.4.1	<i>Viewing the electrode Slope Factor</i>	40
7.4.2	<i>Viewing the % Saturation Offset (Only available in % Saturation or Temperature Set Up menu):</i>	40
7.4.3	<i>Viewing the 100% Saturation mV value</i>	41
7.4.4	<i>Viewing the 0% Saturation mV value</i>	41
7.5	(ATO.4) AUTOMATIC OFF.....	43
7.6	(rSt.5) RESET TO FACTORY DEFAULT.....	44
7.6.1	<i>Calibration Reset</i>	44
7.6.2	<i>User Reset</i>	46
7.7	(OFS.6) % SATURATION OFFSET ADJUSTMENT.....	47
7.8	(DPR.7) DISSOLVED OXYGEN PARAMETERS.....	49
7.8.1	<i>Pressure Setting Adjustment</i>	49
7.8.2	<i>Salinity Setting Adjustment</i>	51
8	PROBE CARE AND MAINTENANCE.....	52
8.1	PROBE CARE.....	53
8.2	PRE-MEMBRANED CAPS REPLACEMENT.....	53
8.3	TO REPLACE THE PROBE PRE-MEMBRANED CAP.....	54

8.4	ELECTROLYTE SOLUTION	55
9	 TROUBLE-SHOOTING GUIDE.....	56
10	 ERROR MESSAGES.....	57
11	 FACTORY DEFAULT SETTINGS.....	58
12	 SPECIFICATIONS.....	60
13	 ACCESSORIES.....	62
14	 ADDITIONAL INFORMATION.....	63
14.1	DISSOLVED OXYGEN	63
14.1.1	<i>General Information</i>	63
14.1.2	<i>Measurement Units.....</i>	65
14.1.3	<i>What Is Being Measured?.....</i>	65
14.1.4	<i>Air Calibration.....</i>	66
14.1.5	<i>Applications.....</i>	66
15	 WARRANTY.....	68
16	 RETURN OF ITEMS.....	69

1 INTRODUCTION

Thank you for purchasing the DO 6 Dissolved Oxygen Handheld. This economy microprocessor-based handheld has a large custom LCD (Liquid Crystal Display) for clear and easy reading.

The DO 6 offers the measurement of dissolved oxygen in the percentage saturation mode and in the concentration mode. Temperature measurement is also available in degrees Celsius. The meter ensures accurate measurement of the Dissolved Oxygen values through its temperature, barometric pressure and salinity compensation features.

Your meter includes a dissolved oxygen probe, refill solution, a rubber boot, 4 alkaline “AAA” batteries, and instruction manual.

Please read this manual thoroughly before operating your meter.

To order other accessories and standard solutions, please refer to the Section on Accessories for more information.

2 DISPLAY & KEYPAD FUNCTIONS

2.1 Display

The meter has a large custom LCD that consists of 14-segment 4 digit display and operation annunciators for Percentage Saturation measurement mode (%), Concentration measurement mode (mg/L or ppm) and Temperature measurement mode in degrees Celsius (T). Other annunciators include "A" (when the ATC function is activated), "CAL" (when meter is in calibration mode) and battery diagram for low battery condition. See Figure 1.

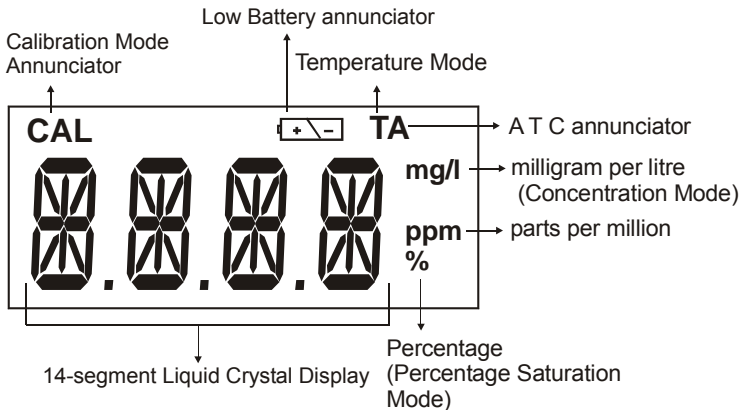







Figure 1: Active LCD display for DO 6

2.2 Keypad

The DO 6 meter has 6 keys on its splash-proof keypad; ON/OFF, HOLD/ENTER CAL, MODE, ▲ and ▼ keys. Some buttons have several functions depending on its mode of operation.

	<p>ON/OFF – Powers on and shuts off the meter. The meter will start in the measurement mode it was in when last switched off.</p>
	<p>CAL – Activates the calibration mode for Percentage Saturation, Concentration and Temperature calibrations.</p> <p>Deactivates calibration or setup without confirming a value in calibration mode.</p>
	<p>HOLD -Activates/Deactivates freezing of the measured reading while in measurement mode.</p> <p>ENTER - Confirms the calibration values in Calibration mode and the selections in the SETUP menu.</p>
 	<p>▲▼ – Sets the calibration values during the Concentration and Temperature calibration.</p> <p>Scrolls through each SETUP and its sub group menu.</p> <p>Set offset adjustments and configuration settings.</p>
	<p>MODE - Selects the measurement option between DO Percentage Saturation measurement; DO Concentration measurement and Temperature measurement.</p> <p>When pressed together with ON/OFF key during power on, SETUP mode is selected. This menu allows meter customization with preferences such as activating ATC selection, DO concentration measurement unit selection, viewing of the last calibration data, viewing of the electrode properties, selecting the auto power off, resetting calibration data or meter settings back to factory default, setting the offset adjustments, setting barometric pressure in Hg or PA for barometric pressure compensation and setting of the salinity value for salinity compensation.</p>

3 PREPARATION

3.1 Inserting & Removing Rubber Boot

- 1) To remove meter from rubber boot, push out from the bottom edges of meter until it is completely out of boot. Ensure that the cables of Dissolved Oxygen electrode or temperature probe are not connected.
- 2) To insert meter into rubber boot, slide in from the top of meter before pushing the bottom edges of meter down to set it into position. Lift up the stand at the back of meter for bench top applications if necessary.



Figure 1: Inserting or removing the rubber boot

3.2 Inserting the Batteries

The battery compartment is found at the back of instrument as shown in Figure 3. To open the battery compartment first remove protective rubber boot/stand then:

- 1) Push in the direction of arrow and lift up the cover.
- 2) Note the polarity of battery before inserting into position.
- 3) After replacement, place cover back and press down until it locks tight.

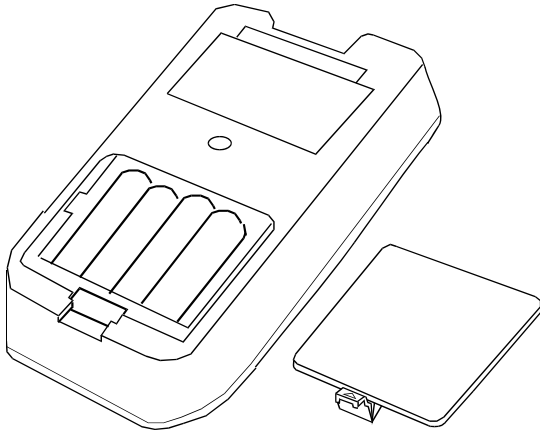

Figure 2: Inserting the batteries

3.3 Battery Replacement

A low battery annunciator in the LCD alerts you when battery power is running low. See Figure 4. Replace with the same type as recommended by the manufacturer.



Figure 3: Low Battery Condition

Caution: Power off the meter when changing battery.

3.4 Dissolved Oxygen Probe Information

The DO 6 is supplied with a Dissolved Oxygen Probe that works on galvanic principle, that is, it does not require any polarising voltage from your meter. Rather it will generate a millivolt signal proportional to the amount of oxygen in the solution.

Your DO Probe has a twin cable, one with a BNC connector for the DO measurement input, and the other with a phono jack plug for the temperature measurement input. Its sensing area consists of a cathode, anode, and an inner electrolyte which is separated from your sample solution by an oxygen permeable membrane pre-membraned to the probe's detachable cap. Re conditioning of your probe is made easy with the introduction of this specially designed detachable pre-membraned cap.

This light weight probe (93X233912 /35642-50) has a built-in temperature sensor for Automatic Temperature Compensation (ATC) with 12mm diameter epoxy body housing and 16 mm diameter Noryl detachable cap. Its compact sensing area reduces air entrapment which makes it easy to obtain fast, accurate and stable readings. Simply stir the probe in the solution being measured. Shaking will aid to remove bubbles if needed before taking a reading. Also, always ensure to remove water drops from the membrane when calibrating in air.

Proper use of probe is essential to ensure that the optimum measurement is taken in a short

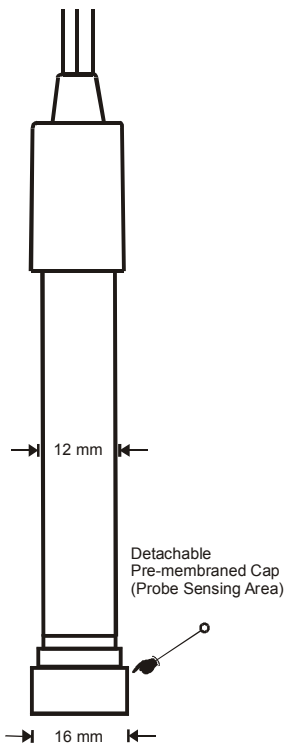

Figure 4: 12 mm Galvanic DO probe (93X233912 / 35642-50)

time. Always immerse the probe beyond the pre-membraned cap. The minimum water flow rate is 2 inch/second across membrane. The temperature range for use is within 0 to 50 °C.

Always ensure that the probe's membrane is protected against any scratches or dents. The whole pre-membraned cap has to be replaced if the membrane is damaged. It is also important to keep the membrane clean so as to produce an optimum and accurate measurement.

See Section 8 - "*Probe Care and Maintenance*" for more information.

3.5 Connecting the Probe to Meter

- 1) Insert the BNC connector from the electrode to the BNC connector socket on the meter accordingly and rotate connector clockwise until it locks. See Figure below.
- 2) To remove, simply rotate the connector in counter-clockwise direction until it unlocks, and slide the connector off the socket.
- 3) Plug the phono jack of temperature sensor into the phono socket of the meter as shown in Figure below.

Caution: Do not pull or force the probe cord or the probe wires might disconnect.

Note: Keep connectors clean. Do not touch connector with soiled hands.

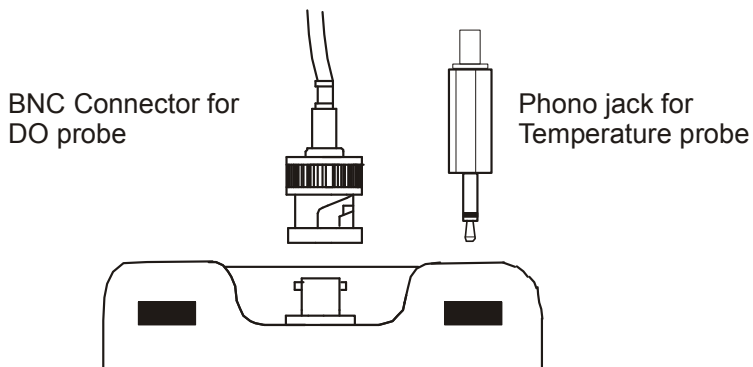

Figure 5: DO 6 probe to meter connections

3.6 Switching the Meter On

When switching the meter on, it will go through a series of display, eventually showing the revision number of the meter before going to the measurement mode. The mode of measurement which the meter displays will be similar to the last measurement mode to which the meter is switched off.

Press **ON/OFF** key to power up your meter.

- 1) All LCD segments will light up for 1.5 seconds.
- 2) The display will then momentarily show the meter's identification "DO 6" with the annunciators for percentage saturation mode and concentration mode.
- 3) The display continues to switch to display meter's revision number for 1.5 seconds before finally showing the measurement mode.
- 4) Either percentage saturation measurement mode, concentration measurement mode or temperature measurement mode will be displayed following the previous measurement mode to which the meter is switched off.

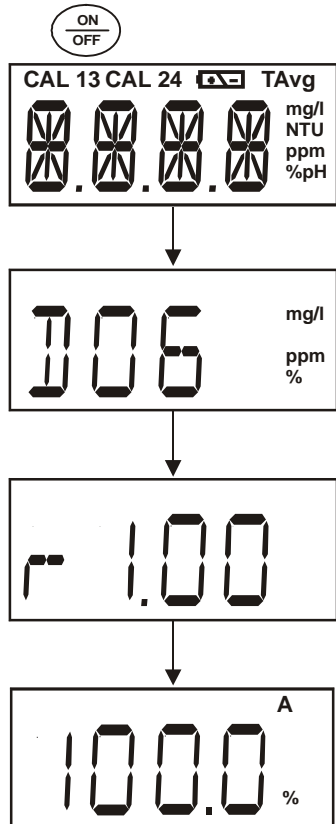

Figure 6: Power Up sequence

3.7 Measurement Mode Selection:- Percentage Saturation (%), Concentration (mg/L)(ppm) and Temperature(T)

By simply pressing the MODE key, you can select the measurement mode of percentage saturation measurement, concentration measurement or temperature measurement.

The customized annunciator shall indicate the selection of the measurement mode.

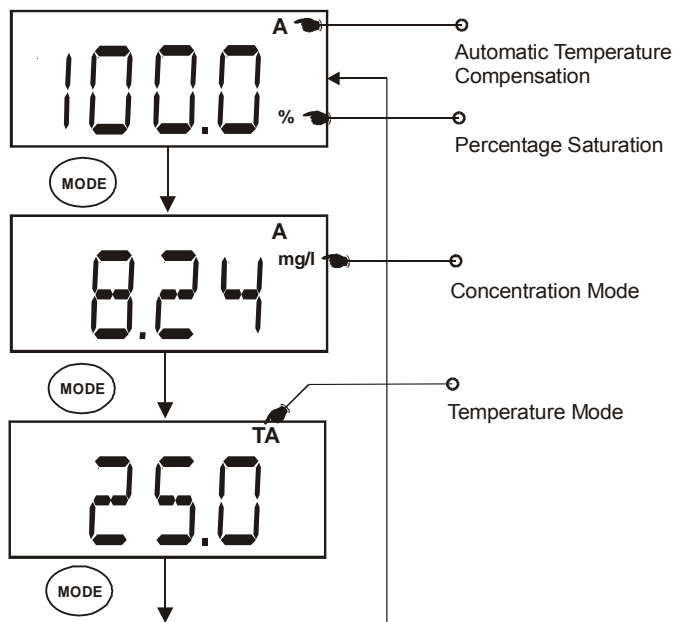

Figure 7: Measurement mode selection using the mode key

4 CALIBRATION

4.1 Important Information on Meter Calibration

Your meter has three measurement modes namely the DO % saturation measurement mode, the DO mg/L (ppm) concentration mode and the Temperature measurement mode.

Since the mg/L (ppm) concentration value of dissolved oxygen varies with temperature, barometric pressure and salinity, the meter with its electrode has to be calibrated with consideration to these factors to ensure a proper measurement. Therefore, it is very important to set the proper temperature, barometric pressure and salinity values in the meter prior to any calibration or measurement process. Since the dissolved oxygen measurements in % saturation will linearly affect the mg/L (ppm) concentration measurement, it is important that the meter has to be first calibrated in the % Saturation mode and temperature mode before commencing the mg/L (ppm) concentration mode calibration.

In % saturation calibration mode, the dissolved oxygen calibration values will vary according to the barometric pressure correction set in the meter. Therefore it is necessary to set the barometric pressure first before proceeding to % Saturation calibration. The following table is an example which explains the acceptance calibration values when % Saturation mode calibration is attempted under different absolute value and under two different barometric pressures.

% Saturation factory default value	Acceptance Calibration Value (760mmHg)	Acceptance Calibration Value (700mmHg)
less than 10%	0%	0%
10.1% to 49.9%	Err.1 (error 1)	Err.1 (error 1)
50% to 200%	100%	92.1%

In the mg/L (ppm) concentration calibration mode, barometric pressure, salinity and temperature of the calibration sample needs to be set in the meter prior to calibration. Since the pressure has already been set in the % saturation calibration which is done earlier and assuming that the calibration is done on the same barometric pressure and if you are using the temperature sensor in automatic temperature compensation mode, you only need to input the known salinity of the calibration sample to the meter. The dissolved oxygen mg/L (ppm) concentration value can then be calibrated to the known sample concentration calibration value. Note that the concentration calibration window is +/- 40% of the factory default value. However the minimum point of calibration is 2 mg/L.

When you recalibrate your meter in % saturation mode, old calibrations in % saturation will be replaced while the % saturation offset adjustment will be erased. However, recalibration in the mg/L (ppm) concentration mode will only replace the old calibration in the concentration mode and do not affect the calibration in the percentage saturation mode.

To completely recalibrate your meter, or when you use a replacement electrode, it is best to clear all calibration data. To erase all the old calibration data completely, see Section 7.6 (rSt.5) Reset to Factory Default

4.2 Preparing the Meter for Calibration

Before starting calibration, make sure you are in the correct measurement mode and in the correct calibration sequence. The temperature and the % Saturation calibration must be done first before attempting to do the mg/L (ppm) Concentration calibration.

In % Saturation, the meter is able to perform either a one point calibration or a 2 point calibration. For one point calibration, it is recommended that you perform a 100% Saturation calibration in saturated air. If you opt for 2 point calibration, you can calibrate for 100% Saturation in saturated air and 0% Saturation using a zero oxygen solution. The meter will take several minutes to reach 0% Saturation value after submersion into the zero solution.

Rinse the probe well in the de-ionized (DI) water or rinse solution and wipe the probe carefully taking care of the membrane.

Calibrate the meter in all the modes to ensure the highest accuracy throughout the DO measurement range. In % Saturation calibration, should there be a

calibration failure for 0% Saturation slope calibration; the meter may have exceeded the limit of 10% of the factory calibrated absolute value. The sensor may have to be re- conditioned. Also, note that the DO 6 meter will not perform 0% or 100% Saturation calibration for absolute value ranging from 10.1% to 49.9%. The meter also will not perform the mg/L (ppm) Concentration calibration for an absolute value of less than 2.00 mg/L (ppm) or calibration which is out of its window tolerance of +/- 40% from the factory default value. An error message of "Err.1" will be indicated and will return the meter to the measurement mode.

All new calibration values will automatically override the existing data. It is recommended to calibrate the meter periodically and or if it is suspected to be inaccurate.

Always rinse the probe with either DI water or rinse solution before and after each calibration/sample measurement. When calibrating in air, make sure that any water droplets from the probe's membrane are removed.

For details please refer to Section 8 - PROBE CARE AND MAINTENANCE.

Note: The DO6 factory calibrated default value is in respect to 760mm Hg or 101.3 kPa barometric pressure (sea level). To set the barometric pressure to different value, see Section 5.3.1 Pressure Setting Adjustment.

4.3 Temperature Calibration

DO mg/L (ppm) Concentration measurement is dependent on the temperature of the sample to be measured. Most users will choose to have the DO6 automatically compensate for temperature using the temperature sensor that is built into the DO probe. However, it is possible to manually enter a known temperature to the meter (manual temperature compensation). The built-in temperature sensor of the DO6 probe is factory calibrated. However, the temperature can be re-calibrated if needed and is recommended when a replacement probe is used.

Before calibration, ensure that the meter displays annunciator "A" to indicate that it is in automatic temperature compensation mode. Please see Set Up menu on page 36 for its activation procedure.

- 1) Switch the meter on. Press MODE to select temperature mode. The display should show the annunciator "T" for temperature mode and "A" for automatic temperature compensation mode.
- 2) Dip the probe to a solution of known temperature (i.e. a temperature bath). Allow some time for the reading to stabilize.
- 3) Press the CAL key. The CAL indicator will appear and blinks above the display. The temperature value displayed is with respect to the factory default calibration.

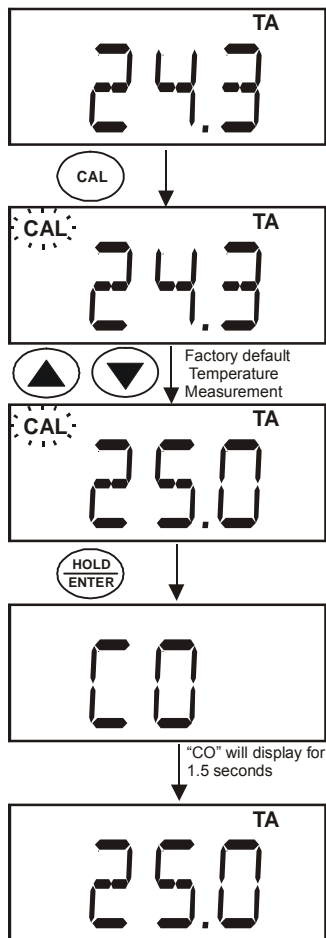

Figure 8: Temperature Calibration Sequence

- 4) Press the ▲ and ▼ keys to adjust the meter reading to the correct temperature value (i.e. the temperature of the temperature bath)
- 5) Press the HOLD/ENTER key to confirm temperature calibration and return to measurement mode.

NOTE:

To exit from Temperature Calibration mode without confirming the calibration, press CAL instead of HOLD/ENTER.

Temperature calibration is restricted to $\pm 5^{\circ}\text{C}$ from the factory default temperature measurement displayed during calibration.

4.4 Dissolved Oxygen Calibration in % Saturation

You can calibrate this meter quickly and easily in air. The exact calibration value depends on barometric pressure. The meter is set to a factory default of 760 mm Hg, which results in a calibration value of 100% Saturation in air.

NOTE: If the barometric pressure setting has been changed from 760 mm Hg, the calibration value in air will automatically adjust to a value other than 100%. The adjusted value will be correct for the new barometric pressure setting.

See Section 5.3.1 Pressure Setting Adjustment on page 26 to change the pressure setting.

4.4.1 *To calibrate 100% Saturation:*

- 1) Rinse the probe well with DI water or rinse solution. Do not touch the membrane.
- 2) Press the MODE key to select the % Saturation mode.
- 3) Hold the probe in the air with the sensor facing downwards. Wait for the reading to stabilize.
- 4) Press the CAL key. The display will show the intended percentage calibration point (100%) with a CAL indicator at the top corner for 1.5 seconds. The CAL indicator will then

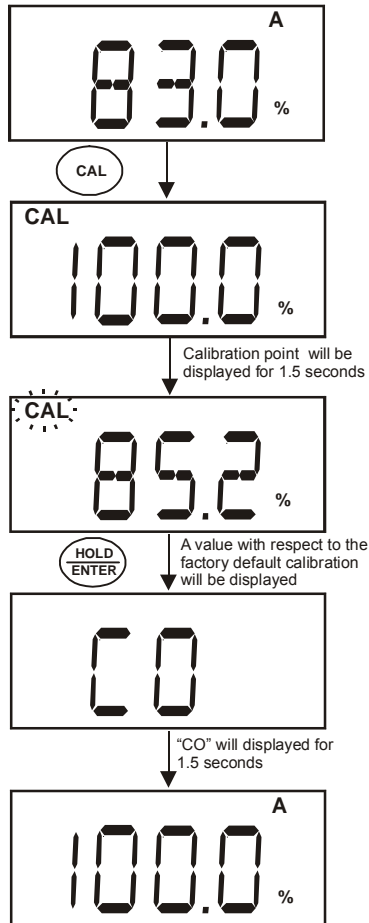

Figure 9: 100% Saturation Calibration

blink and the display will show a value which is with respect to the factory default calibration.

NOTES:

When calibration is attempted on a factory calibrated absolute value measurement of 10.1% to 49.9%, the display will show the absolute value measurement for 1.5 seconds before displaying Err.1 and goes to the measurement mode.

- 5) Press the HOLD/ENTER key to confirm the calibration. The meter displays "CO" for 1.5 seconds and automatically calibrates to 100.0% air saturation and returns to measurement mode.

Note: You can offset your % DO calibration. See Section 7.7 (OFS.6) % Saturation Offset Adjustment for directions.

4.4.2 To calibrate 0% Saturation

- 1) Rinse the probe well with DI water or rinse solution.
- 2) Press the MODE key to select the % Saturation mode, if necessary.
- 3) Dip the probe into the zero oxygen solution. Wait for the reading to stabilize.
- 4) Press the CAL key. The display will show the intended percentage calibration point (0%) with a CAL indicator at the top corner for 1.5 seconds. The CAL indicator will then blink and the display will show a value which is with respect to the factory default calibration.

Note: When calibration is attempted on a factory calibrated absolute value measurement of 10.1% to 49.9%, the display will show the absolute value measurement for 1.5 seconds before displaying Err.1 and goes to the measurement mode.

- 5) Press the HOLD/ENTER key to confirm the calibration. The meter displays "CO" for 1.5 seconds and automatically calibrates to 0.0% Saturation and returns to measurement mode.

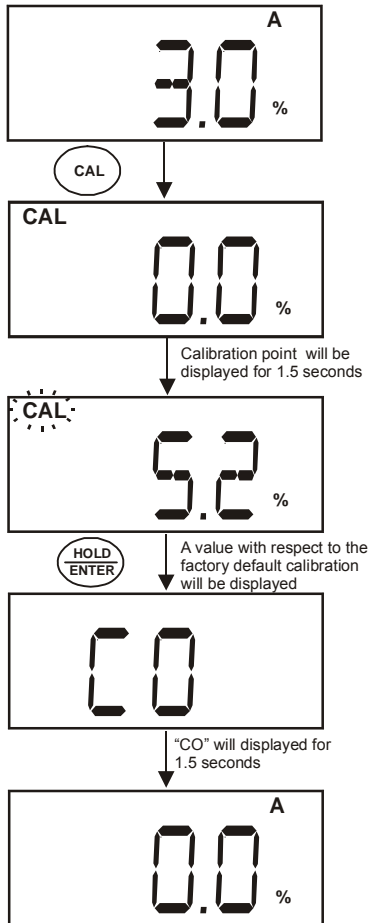

Figure 10: 0% Saturation Calibration

4.5 Dissolved Oxygen Calibration in mg/L or ppm concentration mode

Calibrating the meter to 100% Saturation will also calibrate the concentration mode at the value in mg/L corresponding to 100% Saturation. This should produce acceptable results in most applications.

This meter also lets you make a calibration adjustment in mg/L (ppm) Concentration mode without affecting your % Saturation calibration.

To select between mg/L and ppm units, see page 38, "Selection of mg/L or ppm mode".

4.5.1 *To calibrate in mg/L (ppm) Concentration mode:*

- 1) Calibrate 100% Saturation as per Section 4.4.
- 2) Rinse the probe well with DI water or rinse solution. Wipe the outside of the probe carefully (do not touch the membrane).
- 3) Dip the probe into a sample of known oxygen concentration. Wait for the reading to stabilize.
- 4) Press the MODE key to select the mg/L (ppm) Concentration mode.
- 5) Press the CAL key. The display will show a value which is with respect to

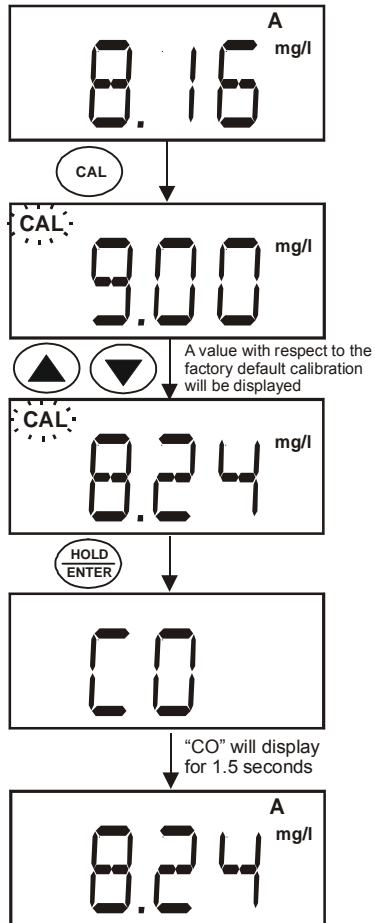

**Figure 11: mg/L (ppm)
Concentration Calibration Sequence**

the factory default calibration with a CAL indicator blinking at the corner of the display.

- 6) Press the ▲ and ▼ keys to adjust the reading to the known oxygen concentration of the sample.
- 7) Press the HOLD/ENTER key to confirm the calibration. The meter will display "CO" for 1.5 seconds and automatically calibrates to the value you have entered and returns to the measurement mode.

NOTES: The concentration calibration window is +/- 40% of the factory default value. However, the minimum point of calibration is 2 mg/L. In an event where the default measured value is less than 2 mg/L and a calibration is attempted, the display will show "2.00" and then error message "Err.1" will be displayed momentarily before returning to measurement mode.

You can change the barometric pressure value and salinity value in the mg/L (ppm) Set Up menu (see Section 7.8.1 and 7.8.2 for Pressure Setting Adjustment and Salinity Setting Adjustment). Please refer to page 23 if you are intending to use manual temperature compensation.

5 MEASUREMENT

The DO 6 meter is capable of taking measurements with automatic or manual temperature compensation.

5.1 With Automatic Temperature Compensation (ATC)

For Automatic temperature compensation, make sure the phono jack of the probe (see Figure 6 in Section 3.5) is securely inserted. The ATC annunciator "A" will be blinking if the ATC probe is disconnected. Activate the "A.ATC" mode in the set up menu, if necessary. See page 36.

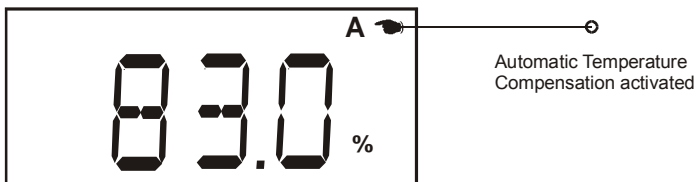

Figure 12: Automatic Temperature Compensation

5.2 Manual Temperature Compensation

For manual temperature compensation, simply deactivate the "A.ATC" mode as explained in the set up menu on page 36. The automatic temperature compensation annunciator "A" will not be displayed to represent that the meter is in manual temperature compensation mode.

To use manual temperature compensation, you need to enter the temperature value of your process into the meter. You can select any temperature between 0 and 50 °C. Default value is 25 °C.

- 1) Switch on the meter and if necessary, press MODE key to select temperature measurement mode.
- 2) Press CAL key to start temperature calibration process.
- 3) The "CAL" indicator will start blinking and the display will show the last manual set temperature value.
- 4) Check the temperature of your sample using an accurate reference thermometer. Wait for the thermometer value to stabilize. Press the ▲ or ▼ key of your meter to manually set its temperature value according to the value of the reference thermometer used.

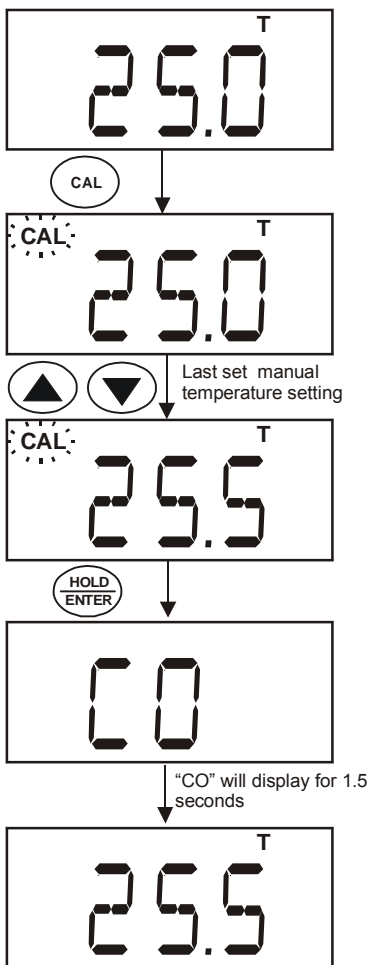

Figure 13: Manual Temperature Compensation value selection sequence

- 5) Press the HOLD/ENTER key to confirm the manual temperature setting made. The "CO" indicator will appear for 1.5 seconds before the display returns to the measurement mode.

Taking Measurements

During measurement, care must be taken to ensure that the probe's membrane surface does not touch anything. Stir around the solution to prevent any air bubbles from being trapped on the membrane before taking a reading. Also, DO NOT immerse the probe fully or allow the water level to pass the neck of the probe, since it is NOT waterproof.

IMPORTANT: Since the DO probe consumes oxygen from the sample, the sample must constantly flow past the membrane to achieve more accurate readings. You can use a stirrer to accomplish this.

5.2.1 To take measurements:

- 1) Rinse the probe well with DI water or rinse solution.
- 2) Select the appropriate measurement mode. Press the MODE key to toggle between modes:
 - a. Percentage Saturation (%)
 - b. Concentration (mg/L) or (ppm)
 - c. Temperature (T)
- 3) Dip the probe into the sample. Stir the solution gently to homogenize the sample. Make sure that the sample is continuously flowing past the membrane sensor.
- 4) Take your measurements once your meter reading has stabilized.

Note: "Ur"/"Or" will be displayed if the instruments exceeds the specified measuring range. See Section 12 for range specification.

To select between mg/L and ppm units, see Set Up menu on page 38.

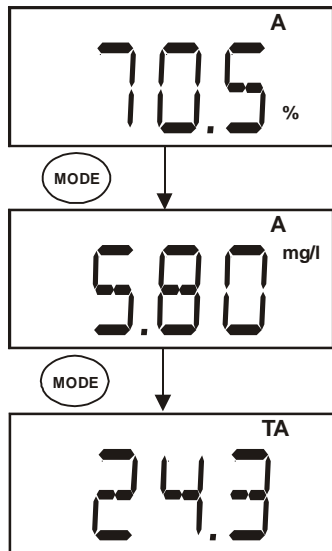

Figure 14: Measurement mode

5.3 Taking Pressure/Salinity Compensated DO Measurements

In taking pressure and salinity compensated DO measurements, the pressure and salinity values of your measurements need to be adjusted from the Set Up menu. The pressure setting adjustment feature is available when Set Up menu is derived from the % Saturation mode, mg/L (ppm) Concentration mode or Temperature mode. Salinity setting feature, on the other hand, will only be available when Set Up menu is derived from the mg/L (ppm) Concentration mode. See Section 7.1- Advanced Setup Overview for more information.

During measurement, the DO meter will automatically compensate for salinity and pressure based on the values entered in the Set Up Menu. The meter is factory set at 760 mm Hg (101.3 kPa) barometric pressure setting and a salinity factor of 0.0 ppt.

5.3.1 Pressure Setting Adjustment

(See Figure 16 for flow chart explanation)

- 1) Switch off your meter in mg/L (ppm) Concentration mode.
- 2) While pressing and hold the MODE key, switch on the meter by pressing the ON/OFF key.
- 3) Once the ON/OFF key is released, the meter will enter the Set Up menu by displaying "SET.P". By releasing the MODE key, the display will show the configuration menu "COF.1". See section 7 – Advanced Setup Functions.
- 4) Press the ▲ and ▼ keys to scroll through the Set Up main group menu till the display shows "DPr.7".
- 5) Press the HOLD/ENTER key and the meter will enter the barometric pressure units selection menu with the display showing one of two; either "A.HG" for mm Hg or "A.PA" for kilo Pascal, depending on what the meter's last set up was.
- 6) Use the ▲ and ▼ keys to toggle between the two units of pressure measurement and press the HOLD/ENTER key to confirm selection.

- 7) Use the ▲ and ▼ keys to set the pressure value and press the HOLD/ENTER to confirm the setting. A confirmation indicator “CO” will be displayed for 1.5 seconds before the meter shows the next display of Salinity setting “b.SAL”. If the Set Up menu is derived from other than the mg/L (ppm) Concentration mode, the meter will return to the Set Up main group menu “DPr.7”.
- 8) Press CAL key to return to measurement mode, or continue to make a salinity setting adjustment.

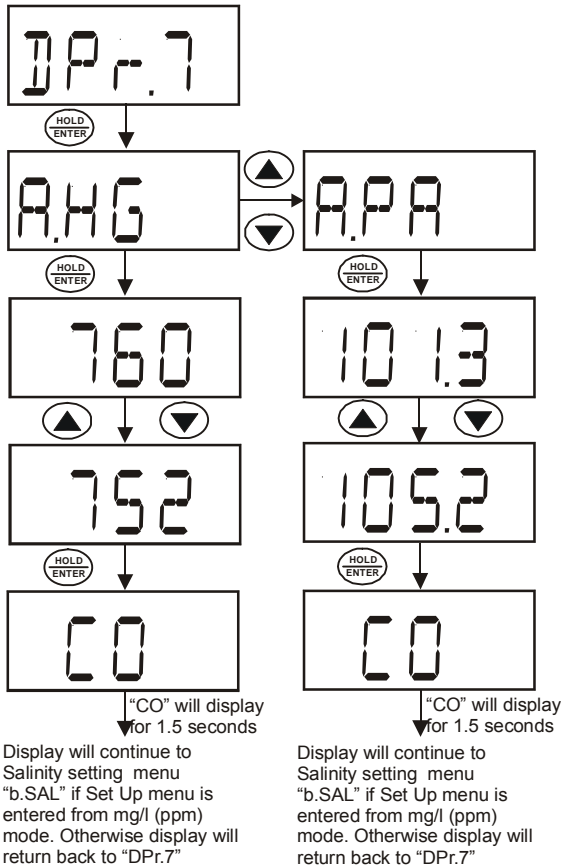

Figure 15: Pressure Setting Adjustment Sequence

5.3.2 Salinity Setting Adjustment

NOTE: This mode is available only from the mg/L (ppm) Concentration Set Up menu.

- 1) Repeat steps 1 to 5 as in the steps of Pressure Setting Adjustment.
- 2) Press the HOLD/ENTER key twice till the meter displays the Salinity setting mode "b.SAL".
- 3) Press the HOLD/ENTER key to enter the Salinity setting mode.
- 4) Use the ▲ and ▼ keys to enter the salinity of your solution in parts per thousand (ppt). Factory default is 0.0. Salinity values up to 50 ppt can be entered.
- 5) Press HOLD/ENTER key to confirm the value. A confirmation indicator "CO" will be displayed for 1.5 seconds before returning to the main group menu "DPr.7".
- 6) Press CAL key to return to the measurement mode.

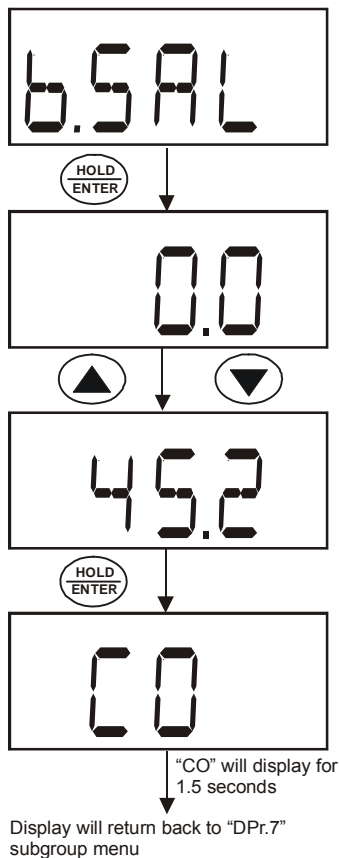

Figure 16: Salinity Setting Adjustment Sequence

6 HOLD FUNCTION

This feature lets you freeze the display for a delayed observation. **HOLD** can be used in any measurement mode.

- 1) To hold a measurement, press the **HOLD/ENTER** key while in measurement mode. The %, mg/L, ppm or T annunciator in the display will start blinking to indicate that the measurement is being held.
- 2) To release the held value, press the **HOLD/ENTER** again. The annunciator will stop blinking to indicate that the held value has been released.
- 3) Continue to take measurements.

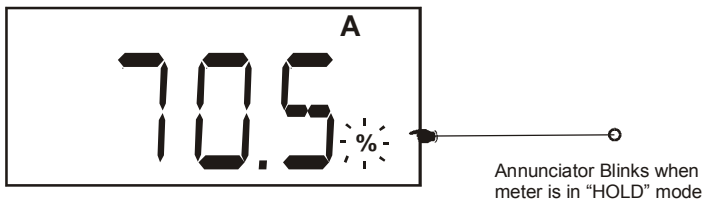

Figure 17: Unit in HOLD mode

Note: This meter has a selectable auto off feature which when activated will shut the meter off automatically after 20 minutes of non use.

If the meter is shut off either automatically or manually, the HOLD value will be lost

7 ADVANCED SETUP FUNCTIONS

7.1 Advanced Setup Overview

The advanced setup mode lets you customize your meter's preferences and defaults. There are two Set Up menus: - one which is derived from the % Saturation or Temperature mode and the other is derived from the mg/L (ppm) Concentration mode.

7.1.1 *To enter the % Saturation or Temperature Set Up menu:*

- 1) Make sure that the meter is switched-off while in the % Saturation or Temperature measurement mode.
- 2) With the MODE key pressed, power the unit on by pressing the ON key. Release the ON key before releasing the MODE key.
- 3) "SEt.P" indicator will appear momentarily and "COF.1" will appear next.
- 4) You are now in the % Saturation or Temperature Set Up menu.

7.1.2 *To enter the mg/L (ppm) Concentration Set Up menu:*

- 5) Switch off the meter in the mg/L (ppm) Concentration measurement mode.
- 6) Repeat steps 2 to 3 as above and you will be in the mg/L (ppm) Concentration Set Up menu.

The following table combines the explanation for the features available in both Set Up menus. Figures 19 and 20 give an overall view of the Set Up sequence for the % Saturation or Temperature Set Up menu and the mg/L (ppm) Concentration Set Up menu.

The image shows a rectangular LCD display with a black border. Inside, the text 'SEt.P' is displayed in a white, seven-segment font. The 't' is lowercase and smaller than the other characters.

SEt.P – Enter Set Up Menu

The image shows a rectangular LCD display with a black border. Inside, the text 'COF.1' is displayed in a white, seven-segment font.

COF.1 – Enter Configuration Menu

A.ATC – Selection for automatic temperature compensation.

b.DO – Selection of mg/L or ppm of the concentration mode measurement. (Only available in Concentration Set Up menu)

The image shows a rectangular LCD display with a black border. Inside, the text 'CAL.2' is displayed in a white, seven-segment font.

CAL.2 – Viewing the latest Calibration data

'View only' parameter for the latest calibration data of the DO % Saturation calibration and the DO mg/L (ppm) Concentration calibration. Calibration data will be viewed according to its respective Set Up menu.

The image shows a rectangular LCD display with a black border. Inside, the text 'ELE.3' is displayed in a white, seven-segment font.

ELE.3 – Viewing the Electrode properties

FACT – Viewing the Slope Factor

OFS – Viewing the % Saturation offset adjustment. (Only available in % Saturation Set Up menu)

HI.mV – Viewing the mV value for 100% Saturation

LO.mV – Viewing the mV value for 0% Saturation

The image shows a rectangular LCD display with a black border. Inside, the text 'AtO.4' is displayed in a white, seven-segment font. The 't' is lowercase and smaller than the other characters.

AtO.4 – Selection of automatic power off (20 minutes from the last key press)

The image shows a rectangular LCD display with a black border. Inside, the text 'rSt.5' is displayed in a white, seven-segment font. The 'r' is lowercase and smaller than the other characters.

rSt.5 – Enter Reset Menu

A.CAL – Selection of Calibration Reset (Clear only Calibration and its Data back to factory default condition)

b.USR – Selection of User Reset (Clear all user setting back to factory default condition)

A rectangular digital display with a black border showing the text 'OFS.6' in a white, segmented font.

OFS.6 - % Saturation Offset Adjustment (Only available in % Saturation Set Up menu)

A rectangular digital display with a black border showing the text 'DPr.7' in a white, segmented font.

DPr.7 – Enter Barometric Pressure Selection Menu

A.HG – Selection of Barometric Pressure Setting Adjustment in mmHg

A.PA - Selection of Barometric Pressure Setting Adjustment in Kilo Pascal

b.SAL – Enter the Salinity Setting Adjustment Menu (Only available in mg/L (ppm) Concentration Set Up menu)

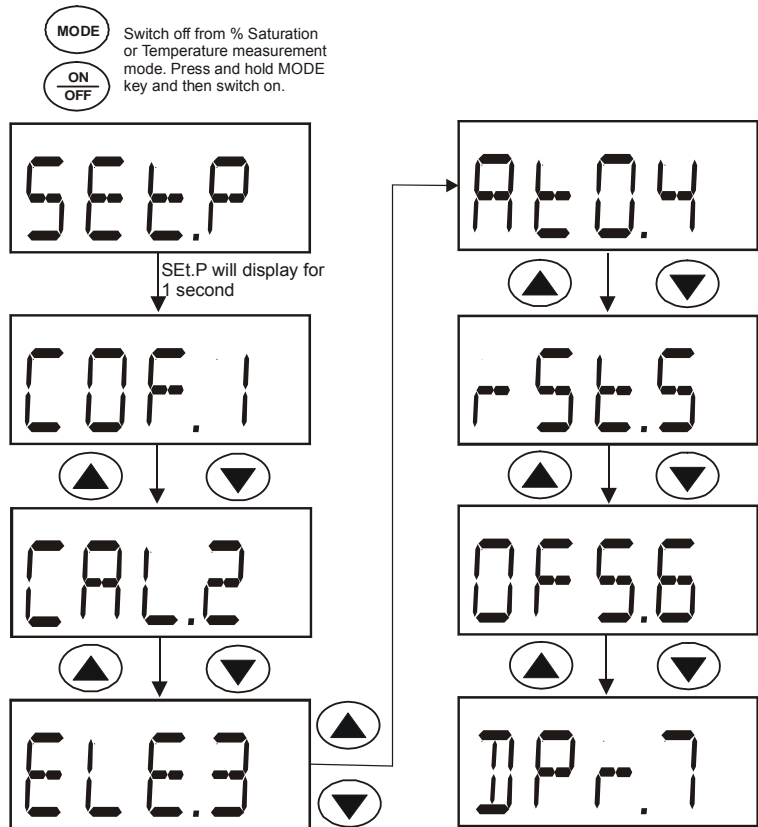

Figure 18: Overview of DO 6 % Saturation or Temperature Setup Menu

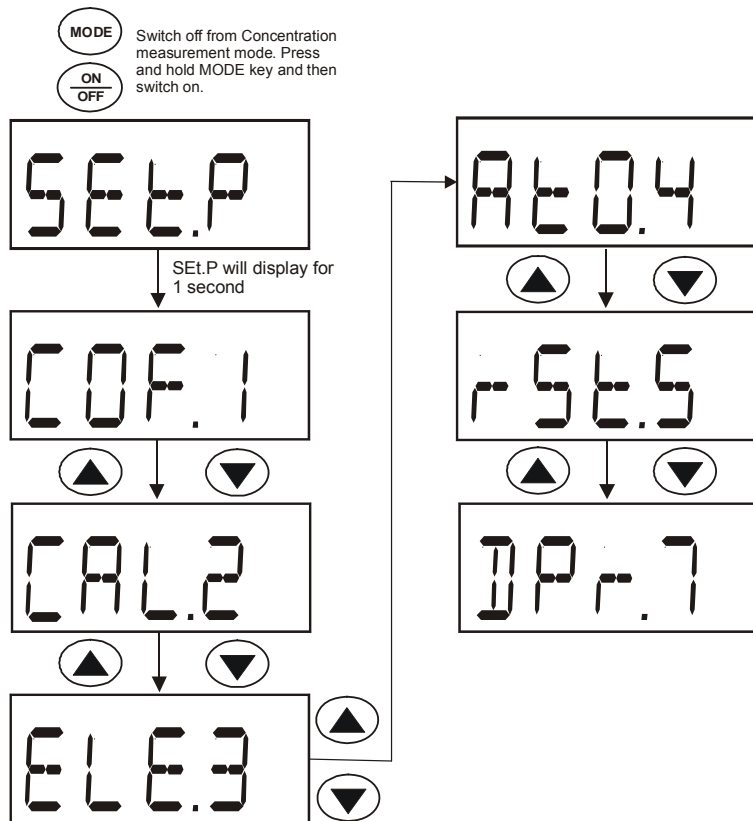

Figure 19: Overview of DO6 Concentration Set up Menu

7.2 (COF.1) Configuration Menu

In this menu, the meter lets you configure the selection of automatic temperature compensation (A) and the selection of mg/L or ppm mode for the mg/L (ppm) Concentration measurement mode. (Second feature is only available in mg/L (ppm) Concentration Set Up menu)

7.2.1 *Selection of Automatic Temperature Compensation*

From "COF.1" of any Set Up menu,

- 1) Press the HOLD/ENTER key for the display to show the Automatic Temperature Compensation selection menu "A.ATC".
- 2) Press the HOLD/ENTER key to enter the ATC selection menu.
- 3) Use the ▲ and ▼ keys to either activate or deactivate the ATC feature.
 - a. YES – activates the ATC
 - b. NO – deactivates the ATC and activates the Manual temperature compensation
- 4) Press the HOLD/ENTER key to confirm your selection.

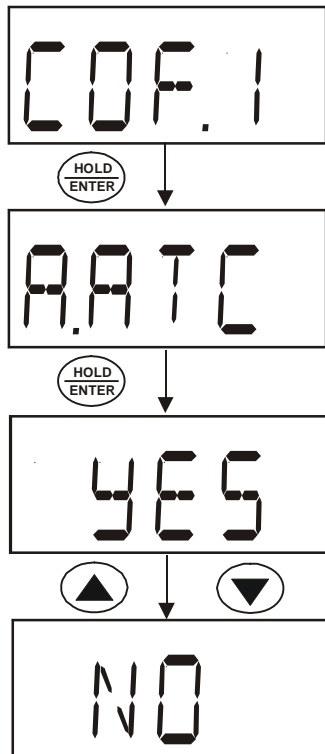

Figure 20: Selection of Automatic or Manual Temperature Compensation

Note: The meter will either return to the main group menu "COF.1" if % Saturation or Temperature Set Up menu is used or will continue to the mg/L or ppm mode configuration if mg/L (ppm) Concentration Set Up menu is used.

7.2.2 Selection of mg/L or ppm mode

From the "COF.1" of the mg/L (ppm) Concentration Set Up menu,

- 1) Press the HOLD/ENTER key thrice to enter the mg/L or (ppm) mode selection menu "b.DO".
- 2) Use the ▲ and ▼ keys to select the desired mode of measurement.
- 3) Press the HOLD/ENTER key to confirm the selection made and to return to the subgroup menu.
- 4) Press the CAL key to return to the measurement mode.

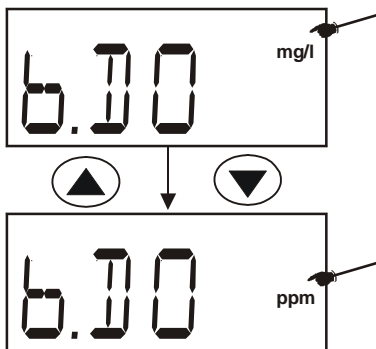

Figure 21: Selection of mg/L or ppm mode

7.3 (CAL.2) Calibration Data

You can view the latest calibration data for the % Saturation and the mg/L (ppm) Concentration calibrations. The calibration data from each mode can be viewed in the Set Up menu respectively.

7.3.1 *Viewing the % Saturation calibration data*

From the % Saturation or Temperature Set Up menu,

- 1) Press the ▲ and ▼ keys to scroll through the main group to enter the viewing menu "CAL.2" for the latest calibration data.
- 2) Press HOLD/ENTER key to view the latest % Saturation calibration data.
- 3) To exit to the main group menu, press the HOLD/ENTER key or the CAL key.
- 4) Press the CAL key to return to the measurement mode.

A rectangular digital display showing the text "CAL.2" in a large, black, seven-segment font.

A circular button with the text "HOLD ENTER" inside. An arrow points from the button down to the next display.

A rectangular digital display showing "CAL" in the top left corner and "100.0%" in the center. The numbers are in a large, black, seven-segment font.

Display will show the latest % saturation calibration if set up menu is selected from the DO % Saturation Mode

A rectangular digital display showing "CAL" in the top left corner and "8.24 mg/l" in the center. The numbers are in a large, black, seven-segment font.

Display will show the latest mg/l or ppm calibration if set up menu is selected from the DO mg/l (ppm) Concentration Mode

7.3.2 *Viewing the mg/L (ppm) Concentration calibration data*

From the mg/L (ppm) Concentration Set Up mode,

- 1) Repeat process 1 to 4 above to view the latest mg/L (ppm) Concentration calibration data.

Figure 22: Viewing the last calibration data for each measurement range

7.4 (ELE.3) Electrode Properties

This menu features data of the electrode properties for diagnostic purposes. The “view only” parameters such as the electrode Slope Factor, % Saturation Offset setting, 100% Saturation mV value and 0% Saturation mV value are very useful in determining the life efficiency of the electrode. These electrode properties can be examined through its data in % Saturation and mg/L (ppm) Concentration which is available in their Set Up menu respectively.

7.4.1 Viewing the electrode Slope Factor

This parameter lets you view and gives an indication of the probe's efficiency. The value displayed is the ratio of the actual value produced by the probe to the theoretical value. The higher the number, the lower the mV output from the probe. The ratio displays from 0.5 to 1.999.

From the % Saturation or Temperature Set Up menu,

- 1) Enter the Set Up menu & scroll by using the ▲ and ▼ keys until the meter displays the Electrode Properties menu “ ELE.3”
- 2) Press the HOLD/ENTER key to enter the menu and view the Slope Factor of the electrode.
- 3) The display will momentarily shows “FACT” before displaying the slope factor value.

7.4.2 Viewing the % Saturation Offset (Only available in % Saturation or Temperature Set Up menu):

This parameter shows you the amount of the % Saturation Offset entered in the other parameter “OFS” (refer to Section 7.7 for instructions).

From Step 3 above,

- 4) Press the HOLD/ENTER key to enter the % Saturation Offset viewing menu.
- 5) The meter will display “OFS” momentarily before displaying the last offset adjustment made.

7.4.3 Viewing the 100% Saturation mV value

This parameter shows the sensor's mV output corresponding to 100% Saturation.

From Step 5 above,

- 6) Press the HOLD/ENTER key. The display will show "HI.mV" momentarily before displaying the sensor's mV output value with respect to 100% Saturation.

7.4.4 Viewing the 0% Saturation mV value

This parameter lets you view the sensor's mV output corresponding to 0% Saturation.

From Step 6 above,

- 7) Press the HOLD/ENTER key. The display will show "LO.mV" momentarily before displaying the sensor's mV output value with respect to 0% Saturation.
- 8) Press the HOLD/ENTER key again to exit to the main group menu. Press CAL to return to the measurement mode.

Note: To view the electrode properties in the mg/L (ppm) Concentration mode, repeat the whole steps above using the mg/L (ppm) Concentration Set Up menu. Viewing of the % Saturation Offset will be skipped in this menu.

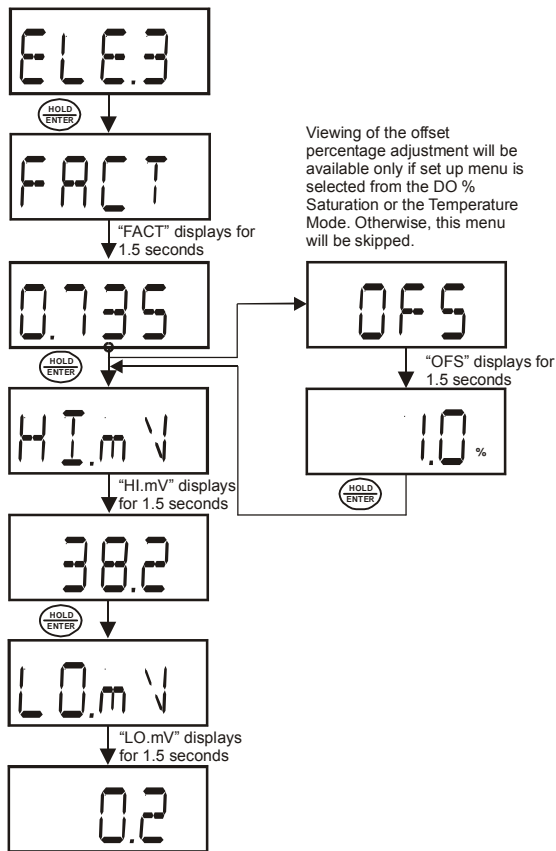

Figure 23: Viewing electrode data sequence

7.5 (AtO.4) Automatic Off

This feature is useful for batteries energy conservation. The meter automatically shuts off 20 minutes from the last key press.

From any Set Up Menu,

- 1) Scroll the Set Up main group menu by using the ▲ and ▼ keys until the meter displays the Automatic Off menu “AtO.4”.
- 2) Press the HOLD/ENTER key to enter the menu.
- 3) Use the ▲ and ▼ keys to activate or deactivate the automatic off selection.
 - a. YES – activates Automatic Off
 - b. NO – deactivates Automatic Off
- 4) Press the HOLD/ENTER key to confirm the selection.
- 5) Press the CAL key to exit the Set Up menu to return to the measurement mode.

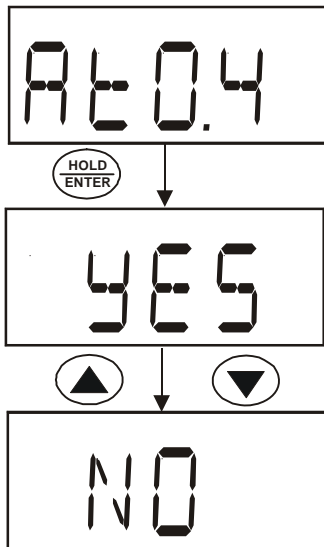

Figure 24: Selection of Automatic Off function

7.6 (rSt.5) Reset to Factory Default

This mode lets you reset all parameters to factory default settings. There are two levels of reset:

- 1) Calibration Reset: - Reset only the calibration values. This clears all previous calibrated values and reset to factory default. See Section 11 for factory default settings.
- 2) User Reset: - Clears all data including calibration and other customized setup functions and reset it to factory default. See Section 11 for factory default settings.

7.6.1 Calibration Reset

From any Set Up menu:

- 1) Scroll the Set Up main group menu by using the ▲ and ▼ keys until the meter displays the Reset to Factory Default menu “rSt.5”.
- 2) Press the HOLD/ENTER key to enter the menu.
- 3) Press the HOLD/ENTER key to enter the Calibration Reset menu “A.CAL”.
- 4) Use the ▲ and ▼ keys to activate or deactivate the Calibration Reset selection.
 - a. YES – activates Calibration Reset

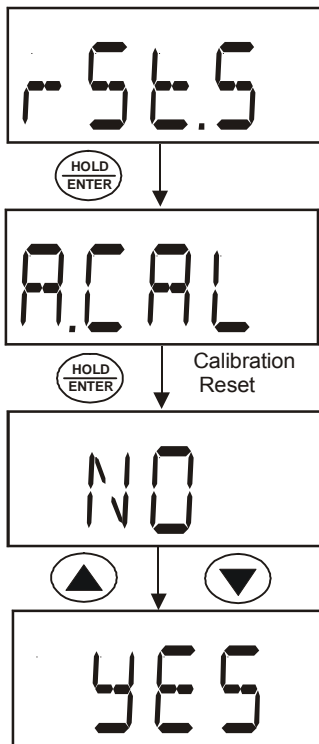

Figure 25: Calibration reset selection

b. NO – deactivates Calibration Reset

- 5) Press HOLD/ENTER key to confirm the selection made.
- 6) If selection is 'YES', meter would immediately return to measurement mode. Otherwise it will return to the main group menu. Press CAL to return to the measurement mode.

Note: When you reset your meter from % Saturation Set Up menu, both % Saturation and mg/L (ppm) Concentration calibrations are reset to factory default. However, calibration reset in the mg/L (ppm) Concentration Set Up menu will only reset the calibration in the concentration mode and do not affect the calibration in the percentage saturation mode.

7.6.2 User Reset

This program clears all data including calibration and other customized setup functions and reset it to factory default.

You can skip Calibration Reset and proceed straight to User Reset

From “rSt.5” menu,

- 1) Press HOLD/ENTER key three times until meter displays the User Reset menu “b.USR”
- 2) Press HOLD/ENTER key to enter the menu.
- 3) Use the ▲ and ▼ keys to activate or deactivate the User Reset selection.
 - a. YES – activates User Reset
 - b. NO – deactivates User Reset
- 4) Press HOLD/ENTER key to confirm the selection made.
- 5) If selection is ‘YES’, meter would immediately return to measurement mode. Otherwise it will return to the main group menu. Press CAL to return to the measurement mode.

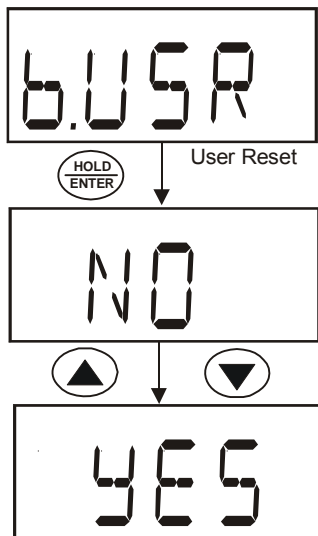

Figure 26: User Reset Selection

7.7 (OFS.6) % Saturation Offset Adjustment

This is a useful feature that allows you to offset meter's value when cross referenced with another DO meter. That way, it can be standardized without you having to perform manual calculation. Your DO 6 meter allows % Saturation Offset adjustment within +/- 10.0% offset and its adjusted offset value can be viewed in the Electrode Properties menu "ELE.3".

From the % Saturation measurement mode,

- 1) Dip the DO electrode in the sample solution and allow the reading to stabilize.
- 2) Check the reading of another DO meter being used as a reference. This reference meter should have its probe immersed in the same sample solution and at the same depth.
- 3) Switch off your meter and enter the % Saturation Set Up menu.
- 4) Scroll the Set Up main group menu by using the ▲ and ▼ keys until the meter displays the % Saturation Offset Adjustment menu "OFS.6".
- 5) Press the HOLD/ENTER key to enter the menu. The display will

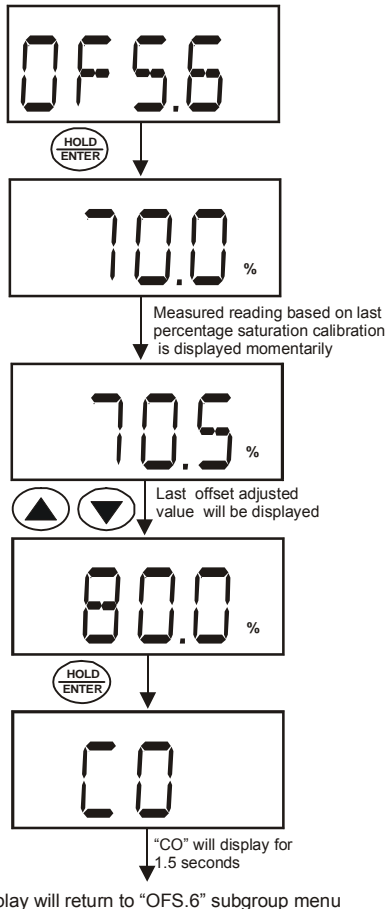

Figure 27: % Saturation Offset Adjustment

momentarily show the measured reading based on the last calibration before displaying the last offset adjusted value.

- 6) Use the ▲ and ▼ keys to enter the new value.
- 7) Press the HOLD/ENTER key to confirm the offset adjustment. "CO" will be displayed for 1.5 seconds before the display returns to the subgroup menu.
- 8) Press CAL key to exit the Set UP menu to return to the measurement mode.

Note: When a user calibration is done, the offset gets reset to zero.

7.8 (DPr.7) Dissolved Oxygen Parameters

This Set Up menu allows you to set the barometric pressure and the salinity value of the sample to be measured. You are given the option to use mmHg or kilo Pascal barometric pressure units. The Salinity value to be entered will be based on ppt and is available in mg/L (ppm) Concentration Set Up menu.

The Set Up menu for barometric pressure correction is "A.Hg" (for mmHg) and "A.PA" (for kilo Pascal) whereas the Salinity menu is indicated as "b.SAL".

7.8.1 *Pressure Setting Adjustment*

- 1) Switch off your meter in mg/L (ppm) Concentration mode.
- 2) While pressing and hold the MODE key, switch on the meter by pressing the ON/OFF key.
- 3) Once the ON/OFF key is released, the meter will enter the Set Up menu by displaying "SEt.P". By releasing the MODE key, the display will show the configuration menu "COF.1".
- 4) Press the ▲ and ▼ keys to scroll through the Set Up main group menu till the display shows "DPr.7".
- 5) Press the HOLD/ENTER key and the meter will enter the barometric pressure unit selection menu with the display showing either the "A.HG" mode or "A.PA" mode.
- 6) Use the ▲ and ▼ keys to toggle between the barometric pressure units and press the HOLD/ENTER key to confirm selection.
- 7) Use the ▲ and ▼ keys to set the pressure value and press the HOLD/ENTER to confirm the setting. A confirmation indicator "CO" will be displayed for 1.5 seconds before the meter shows the next display of Salinity setting "b.SAL". If the Set Up menu is derived from other than the mg/L (ppm) Concentration mode, the meter will return to the Set Up subgroup menu "DPr.7".
- 8) Press CAL key to return to measurement mode, or continue to make a salinity setting adjustment.

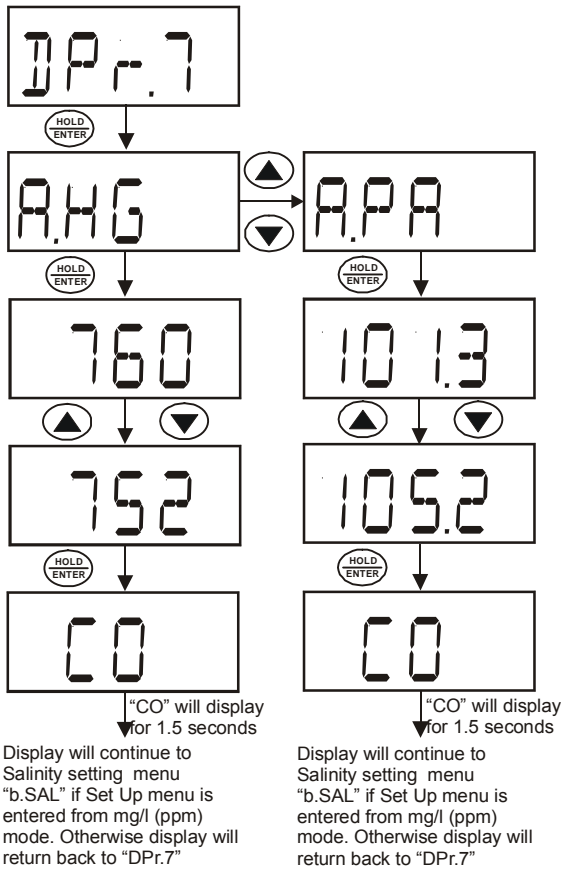

Figure 28: Pressure Setting Adjustment Sequence

7.8.2 Salinity Setting Adjustment

Note: This mode is available only from the mg/L (ppm) Concentration Set Up menu.

- 1) Repeat steps 1 to 5 as in the steps of Pressure Setting Adjustment.
- 2) Press the HOLD/ENTER key twice till the meter displays the Salinity setting mode "b.SAL".
- 3) Press the HOLD/ENTER key to enter the Salinity setting mode.
- 4) Use the ▲ and ▼ keys to enter the salinity of your solution in ppt.

Note: The salinity value is in ppt (parts per thousand)

- 5) Press HOLD/ENTER key to confirm the value. A confirmation indicator "CO" will be displayed for 1.5 seconds before returning to the subgroup menu "DPr.7".
- 6) Press CAL key to return to the measurement mode.

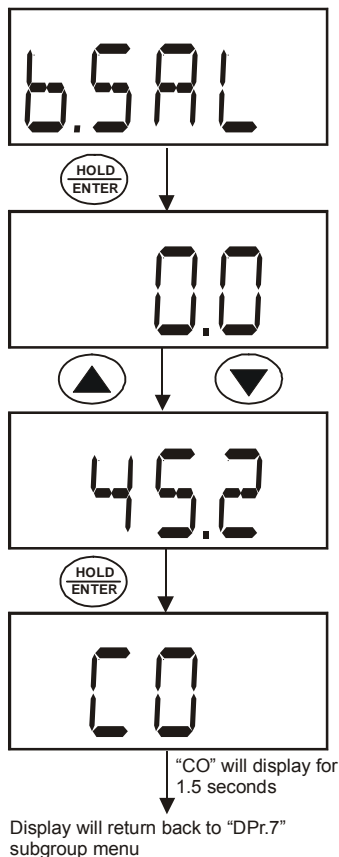

Figure 29: Salinity Setting Adjustment Sequence

8 PROBE CARE AND MAINTENANCE

The DO6 probe is a galvanic measuring element which produces an output proportional to the oxygen present in the medium in which it is placed. The galvanic probe design lets you take measurements immediately – without the typical 15 minute wait of other dissolved oxygen probes.

The probe consists of two parts:

- An upper part consisting of the anode, a cathode, and the dual cable.
- A lower part consisting of a pre-membraned cap, and electrolyte solution.

Oxygen diffuses through the membrane onto the cathode, where it is consumed. This process produces an electrical current which flows through the cable to the meter. The electric current produced is proportional to the oxygen that passes through the membrane and the layer of electrolyte. This makes it possible to measure the partial pressure of oxygen in the sample at a given temperature.

Since the DO in the sample is consumed by the cathode it is essential that a new sample must flow past the membrane of the probe to prevent the occurrence of false readings. The probe uses very little oxygen for its measurement. This enables it to function correctly with liquid movement as low as 2 inch /sec across membrane.

The permeability of the membrane to oxygen varies greatly with temperature. Therefore compensation is needed for this variation. The DO6 probe comes with an in-built Temperature Compensation for the membrane variation.

8.1 Probe Care

Proper care and maintenance will help you receive the maximum probe life and ensure more accurate readings.

Since any deposits on the membrane surface act as a barrier to oxygen diffusing through the membrane, the membrane must be cleaned at regular intervals to assure maximum reliability.

After using the probe, rinse the probe with clean water and wipe it with a soft cloth or paper to avoid any hardening of deposits if necessary. If growth develops on the probe, use a disinfecting chemical to clean.

NOTE: Although the membrane is strong and not easily damaged, wipe it gently while cleaning it. If the membrane is damaged or torn, the probe will no longer function.

There are no special probe storage requirements.

8.2 Pre-Membraned Caps Replacement

Replacement of the pre-membraned cap is required only when you cannot calibrate the probe, or if the membrane is damaged.

Typical membrane damages are punctures or wrinkles caused during measurements or cleaning.

To order replacement probe components or a replacement probe, see Section 13 "Accessories" on page 62.

8.3 To replace the probe pre-membraned cap

- 1) Unscrew counter clockwise the pre-membraned cap from the probe sensing tip and discard.
- 2) Wash the probe under running water.
- 3) Mount the nozzle tip onto the syringe provided. Fill the syringe with the refill solution through the tip of the plastic bottle.
- 4) Hold the probe upside down. Insert the nozzle tip into one of the 4 holes surrounding the silver cathode. Inject the fill solution into the probe body until solution leaks out from the fill hole (approximately 5 mL).
- 5) Replace pre-membraned cap by tightening clockwise until hand tightened.
- 6) Allow at least 1 hour for the electrode to equilibrate before usage.

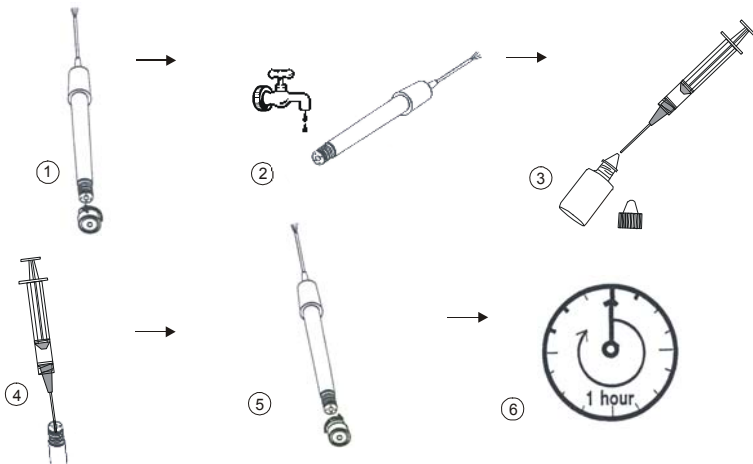

Figure 30: probe pre mebraned cap replacement process

8.4 Electrolyte Solution

The electrolyte solution in your probe's cap will deplete on usage and will need to be replaced periodically.

Your DO probe comes with replacement electrolyte solution. The replacement electrolyte comes premixed and ready to use. To order more electrolyte solution, see "Accessories" section.

9 TROUBLE-SHOOTING GUIDE

Problem	Cause	Solution
No display when turned on	<ul style="list-style-type: none"> a) Batteries not in place b) Batteries not in correct polarity (+ and – position). c) Weak batteries 	<ul style="list-style-type: none"> a) Remove rubber boot/stand. Check that batteries are in place and making good contact. b) Re-insert batteries with correct polarity. c) Replace batteries.
Unstable readings	<ul style="list-style-type: none"> a) Insufficient electrolyte in probe. b) Air bubbles trapped around the probe. c) Dirty or damaged probe d) Probe not deep enough in sample. e) External noise pickup or induction caused by nearby electric motor. f) Broken probe. 	<ul style="list-style-type: none"> a) Fill probe with electrolyte & replace pre-membraned cap. b) Stir or tap probe to remove bubbles. c) Clean the probe and re-calibrate. d) Make sure sample entirely covers the probe sensors. e) Move or switch off interfering motor. f) Replace probe.
Slow response	<ul style="list-style-type: none"> a) Dirty / Oily probe. b) Temperature is changing. 	<ul style="list-style-type: none"> a) Clean probe. See “Probe Care & Maintenance.” b) Allow time for temperature to stabilize
Not responding to key press	<ul style="list-style-type: none"> a) HOLD mode in operation indicated by flashing display. b) Damaged key pad. c) Internal program error. 	<ul style="list-style-type: none"> a) Cancel HOLD mode. b) Return to dealer. c) Reset all internal programs by reinserting batteries.

10 ERROR MESSAGES

LCD Display	Indicates	Cause	Solution
 Low Battery indicator	Low battery level.	Need new batteries or battery connection is bad.	Clean battery contacts. Replace batteries with fresh ones, noting polarity.
"Err 1" in % Saturation Mode	% Saturation Calibration error	Calibration is performed when factory calibrated absolute value is out of calibration range – 10.1% to 49.9%	Check the value of the calibration solution. If zero calibration is done, make sure the limit of 10% is not exceeded. If message persist, recondition your probe.
"Err. 1" in mg/L (ppm) Concentration Mode	Concentration Calibration error	Calibration is performed when the calibration solution factory absolute measurement is below 2.00 mg/L or ppm	Check the calibrating solution to be above 2 mg/L or ppm. Check that the correct temperature and salinity setting has been set prior calibration.
"UR"/"OR" with blinking "A" annunciator in Temperature Mode	ATC probe error, Under Range, Over Range	ATC probe is removed or broken while the meter has the ATC feature activated.	Check the probe's temperature input phono jack connection to the meter. Ensure probe is not broken or punctured.
"----" with blinking "A" annunciator in % Saturation and Concentration Mode	ATC probe error	ATC probe is removed or broken while the meter has the ATC feature activated.	Check the probe's temperature input phono jack connection to the meter. Ensure probe is not broken or punctured.

11 FACTORY DEFAULT SETTINGS

Setting Menu	FUNCTION	PARAMETER OPTING KEYS	PARAMETER OPTIONS	DEFAULT SETTING
COF.1	Unit Configuration	Parameter Title Only	Parameter Title Only	
A.ATC	Selection of Automatic or Manual Temperature Compensation	▲ and ▼	YES; NO	YES
b.DO	Selection of mg/L or ppm of the concentration mode	▲ and ▼	mg/L or ppm	mg/L
CAL.2	Viewing the latest calibration data	Viewing Only	Viewing Only	-----
ELE.3	Viewing the Electrode properties	Parameter Title Only	Parameter Title Only	
FACT	Viewing the Slope Factor	Viewing Only	Viewing Only	1.000
OFS	Viewing the % Saturation offset adjustment.	Viewing Only	Viewing Only	0.0%
HI.mV	Viewing the mV value for 100% Saturation	Viewing Only	Viewing Only	50 mV
LO.mV	Viewing the mV value for 0% Saturation	Viewing Only	Viewing Only	0 mV
AtO.4	Selection of automatic power off	▲ and ▼	YES; NO	YES
rSt.5	Reset to factory defaults	Parameter Title Only	Parameter Title Only	
A.CAL	Selection of Calibration Reset	▲ and ▼	NO, YES	NO
b.USR	Selection of User Reset	▲ and ▼	NO, YES	NO
OFS.6	Offset Adjustment (% Saturation)	▲ and ▼	+/- 10.0 of measured reading	0.0%

Setting Menu	FUNCTION	PARAMETER OPTING KEYS	PARAMETER OPTIONS	DEFAULT SETTING
DPr.7	Barometric Pressure Selection Menu	Parameter Title Only	Parameter Title Only	
A.HG	Selection of Barometric Pressure Setting Adjustment in mmHg	▲ and ▼	500 to 1499 mmHg	760 mm Hg
A.PA	Selection of Barometric Pressure Setting Adjustment in Kilo Pascal	▲ and ▼	66.6 to 199.9 kPA	101.3 kPA
b.SAL	Salinity Setting Adjustment	▲ and ▼	0.0 to 50.0 ppt	0.0 ppt
	Setting the Manual Temperature Compensation	CAL, ▲ and ▼	0.0 to 50.0 °C	25.0°C

Note: The HOLD/ENTER key is used to confirm every parameter opted.

12 SPECIFICATIONS

% Saturation Mode Range Resolution Relative accuracy	0.00 – 200.0 % 0.1 % ± 1.5% of Full Scale
mg/L (ppm) Concentration Mode Range Resolution Relative accuracy	0.00 – 20.00 mg/L or ppm 0.01 mg/L; 0.01 ppm ± 1.5% of Full Scale
Temperature Range Resolution Relative accuracy	-5.0 – 105.0 °C 0.1 °C ± 0.5 °C
Salinity Correction Range Resolution Method	0.0 – 50.0 ppt 0.1 ppt Automatic correction after manual input
Barometric Pressure Correction (mm Hg) Range Resolution Method	500 to 1499 mm Hg or 66.6 to 199.9 kPA 1 mm Hg or 0.1 kPA Automatic correction after manual input
Automatic Temperature Compensation	0.0 to 50.0°C
Manual Temperature Compensation	0.0 to 50.0°C
Probe (DO / Temp)	Galvanic / Thermistor
Probe Diameter	Body 12 mm, Cap 16 mm
Response Time	60 seconds to achieve 95% of the reading
% Saturation Calibration Points	100% in saturated air or air-saturated water. 0% in zero oxygen solution

% Saturation Calibration Limits	Factory calibrated absolute value of 10.0% and below for 0% point & 50% to 200% for 100% point.
Concentration Calibration Window	+/- 40% from the factory default measurement value. Minimum reading allowed is 2.00 mg/L (ppm).
Temperature Calibration Window	+/- 5°C from factory default measurement
Offset Adjustments (% Saturation)	+/- 10.0 of reading in Saturation mode
HOLD function	Yes
Auto-Off function	Selectable Auto Off function. (20 minutes after last key press)
Display	Customs Single 4 Digit LCD
Inputs	BNC for DO & 2.5 mm Phono for temperature
Operating Range	0 to 50 °C
Power Requirements	4 AAA-sized batteries (included)
Battery Life	> 700 hours (Alkaline Batteries)
Dimensions	Meter: 14 cm (L) x 7 cm (W) x 3.5 cm (H) Probe: 115 mm (L) x 12 mm (Dia) with 3-ft cable. Probe's membrane housing: 16 mm (Dia)

13 ACCESSORIES

	Eutech Instruments	Oakton Instruments
DO 6 meter and 3m probe kit in hard carrying case	ECDO602K "Ecoscan DO6"	35642-10 "Acorn DO6"
Replacement galvanic DO probe with 10-mL electrolyte. 12-mm dia, 1 meter cable.	ECDO6HANDY	35642-50
DO probe refilling electrolyte	01X211226 (50 mL)	35640-71 (500-mL)
Replacement cap with pre-installed membrane and 10-mL electrolyte	01X241609	35642-55
Hard carrying case	ECECODRYKIT	35632-97
Zero oxygen solution, 500-mL	-	00653-00
Replacement Rubber Boot/Stand	ECRUBBERBOOT	35606-80
Replacement AAA batteries	60X023200	09376-00 (pack of 12)
Pre-membraned Housing	01X241608	-

14 ADDITIONAL INFORMATION

14.1 Dissolved Oxygen

14.1.1 *General Information*

Dissolved Oxygen (DO) refers to the volume of oxygen that is contained in water. There are two main sources of DO in water: from atmosphere and photosynthesis. Waves and tumbling water mix air into the water where oxygen readily dissolves until saturation occurs. Oxygen is also produced by aquatic plants and algae as a by-product of photosynthesis.

The amount of DO that can be held by water depends on 3 factors: water temperature, salinity, and atmospheric pressure.

- 1) Amount of DO increases with decreasing temperature (colder water holds more oxygen);
- 2) Amount of DO increases with decreasing salinity (freshwater holds more oxygen than saltwater does);
- 3) Amount of DO decreases with decreasing atmospheric pressure (amount of DO absorbed in water decreases as altitude increases).

The chart in Figure 32 shows the solubility of DO in mg/L in water at various temperatures.

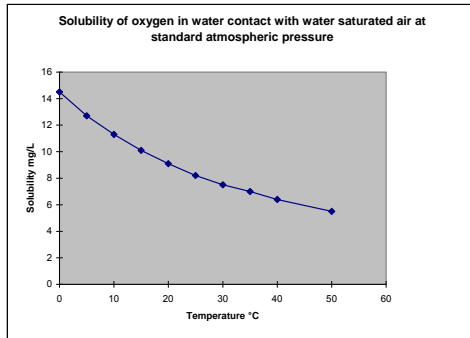

Figure 31: DO Solubility in Water vs Temperature °C

14.1.2 Measurement Units

One measure of DO in water is parts per million (ppm) which is the number of oxygen molecules (O₂) per million total molecules in a sample. Calculating the % Saturation is another way to analyze DO levels. % Saturation is the measured DO level divided by the greatest amount of oxygen that the water could hold under various temperature and atmospheric pressure conditions multiplied by 100.

14.1.3 What Is Being Measured?

DO probes respond to the partial pressure of oxygen in liquid or gas being measured – they measure the “pressure” of oxygen rather than concentration. All of the oxygen entering the probe is consumed at the cathode where it is electrochemically reduced to hydroxyl ions producing an electrical current within the probe:

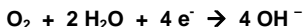

Since all oxygen entering the probe is chemically consumed, the partial pressure of oxygen in the electrolyte is zero. Therefore, a partial pressure gradient exists across the membrane and the rate at which oxygen enters the probe is a function of the partial pressure of oxygen in the gas or in liquid being measured.

When a probe is placed in air saturated water, the current it produces will not be affected by the temperature or salinity of the water. The DO concentration in the water, however, will vary with temperature and salinity. Because it is convenient to report DO concentration in mg/L or ppm, it is necessary to adjust for temperature and salinity of the water to get correct readings in these units.

If DO were to be reported in terms of partial pressure or % Saturation, then temperature and/or salinity compensation for oxygen solubility would not be necessary. Most probes are temperature compensated – i.e. they convert the “partial pressure measurement” to mg/L of DO at whatever temperature the water happens to be at for a given salinity and barometric pressure.

14.1.4 Air Calibration

Understanding the principle of air calibration is easy, once you know that it is partial pressure that the probe is responding to. When the probe is in air, it is measuring the partial pressure of oxygen in air. If water is air saturated, then the partial pressure of oxygen in the water will be the same as it is in air. Therefore, all you need to know is the temperature of the air in which the probe is placed. By consulting solubility tables for oxygen at the particular barometric pressure and salinity of the water being measured, the corresponding concentration (mg/L or ppm) can be found for air saturated water at the air calibration temperature, and the meter can be set accordingly. Because most meters are temperature compensated, they will still give correct readings in mg/L even though the actual water temperature may be different to the air calibration temperature.

Note: The closer the air calibration temperature to the water temperature, the more accurate is the calibration.

14.1.5 Applications

Oxygen is essential for fish, invertebrate, plant, and aerobic bacteria respiration. DO levels below 3 ppm are stressful to most aquatic organisms. Levels below 2 or 1 ppm will not support fish. Fish growth and activity usually require 5 to 6 ppm of DO, an important consideration for Aqua-culture industry.

Low DO indicates a demand on the oxygen of the system. Natural organic material such as leaves accumulate in the stream and create an oxygen demand as it is decomposed. Organic materials from human activities also create an oxygen demand in the system. Micro-organisms consume oxygen as they decompose sewage, urban and agricultural run-off, and discharge from food-processing plants, meat-packing plants and dairies. There is an optimum DO level for this process and if DO level falls too low, the micro-organisms die and the decomposition ceases. If DO level is too high, more power is used than necessary for aeration and the process becomes costly.

In boiler water application, presence of oxygen in the water will increase corrosion and helps build up boiler scale that inhibits heat transfer. In such instance it is critical to keep DO concentration to a minimum.

Some pollutants such as acid mine drainage produce direct chemical demands on oxygen in the water. DO is consumed in the oxidation-reduction reactions of introduced chemical compounds such as nitrate (NO_3^{-}) and ammonia (NH_4^{+}), sulfate (SO_4^{2-}), and sulfite (SO_3^{2-}) and ferrous (Fe_2^{+}) and ferric (Fe_3^{+}) ions.

These are important consideration for water and wastewater treatment industry.

15 WARRANTY

This meter is supplied with a three-year warranty, six-month warranty for electrode against significant deviations in material and workmanship.

If repair or adjustment is necessary and has not been the result of abuse or misuse within the designated period, please return – freight pre-paid – and correction will be made without charge. Eutech Instruments/ Oakton Instruments will determine if the product problem is due to deviations or customer misuse.

Out of warranty products will be repaired on a charged basis.

Exclusions

The warranty on your instrument shall not apply to defects resulting from:

- Improper or inadequate maintenance by customer
- Unauthorized modification or misuse
- Operation outside of the environment specifications of the products

16 RETURN OF ITEMS

Authorization must be obtained from our Customer Service Department or authorized distributor before returning items for any reason. A "Return Goods Authorization" (RGA) form is available through our Authorized Distributor. Please include data regarding the reason the items are to be returned. For your protection, items must be carefully packed to prevent damage in shipment and insured against possible damage or loss. Eutech Instruments/ Oakton Instruments will not be responsible for damage resulting from careless or insufficient packing. A restocking charge will be made on all unauthorized returns.

NOTE:

Eutech Instruments Pte Ltd/ Oakton Instruments reserve the right to make improvements in design, construction, and appearance of products without notice.

For more information on Eutech Instruments/ Oakton Instruments' products, contact your nearest distributor or visit our website listed below:

<p>Oakton Instruments P.O Box 5136, Vernon Hills, IL 60061, USA Tel: (1) 888-462-5866 Fax: (1) 847-247-2984 E-mail: info@4oakton.com Web-site: www.4oakton.com</p>	<p>Eutech Instruments Pte Ltd. Blk 55, Ayer Rajah Crescent, #04-16/24 Singapore 139949 Tel: (65) 6778 6876 Fax: (65) 6773 0836 E-mail: eutech@thermofisher.com Web-site: www.eutechinst.com</p>	<p>Distributed by:</p>
--	---	-------------------------------